



香 港 標 準 及 檢 定 中 心
The Hong Kong Standards and Testing Centre Ltd.

Date: 2004-09-09
No.: HM152143

TEST REPORT

Page 1 of 27

Applicant: Newtech Electronics Ltd.
Unit 4-6, Phase II, Chai Wan Industry City
70 Wing Tai Road, Chaiwan, Hong Kong

Description of Samples: Model name: WEB CAMERA
Brand name: MSN
Model no.: MSNAR-0091

Date Samples Received: 2004-07-29

Date Tested: 2004-08-10 to 2004-08-27

Investigation Requested: Test for EMC requirements of EN55022
(conducted emission only), EN55024, EN61000-3-2 and EN61000-3-3.

Conclusions: The submitted product COMPLIED with the requirements of EN55024: 1998 +A1: 2001 +A2: 2003, EN61000-3-2: 2000 and EN61000-3-3: 1995 +A1: 2001 and partially EN55022: 1998 +A1: 2000+A2: 2003 (conducted emission only), The EMC tests were performed in accordance with the standards described above and on Section 2.2 in this Test Report.

Remarks: ----

for K.C. Lee, EMC
for Chief Executive



This report shall not be reproduced unless with prior written approval from the Hong Kong Standards and Testing Centre.



香 港 標 準 及 檢 定 中 心
The Hong Kong Standards and Testing Centre Ltd.

Date: 2004-09-09

TEST REPORT

Page 2 of 27

No.: HM152143

CONTENT:

Cover	Page 1 of 27
Content	Page 2-3 of 27
<u>1.0 General Details</u>	
1.1 Test Laboratory	Page 4 of 27
1.2 Applicant Details Applicant HKSTC Code Number for Applicant Manufacturer	Page 4 of 27
1.3 Equipment Under Test [EUT] Description of Sample	Page 5 of 27
1.4 Date of Order	Page 5 of 27
1.5 Submitted Samples	Page 5 of 27
1.6 Test Duration	Page 5 of 27
1.7 Country of Origin	Page 5 of 27
1.8 Additional Information of EUT	Page 5 of 27
<u>2.0 Technical Details</u>	
2.1 Investigations Requested	Page 6 of 27
2.2 Test Standards and Results Summary	Page 6-8 of 27
<u>3.0 Test Results</u>	
3.1 Emission	Page 9-16 of 27
3.2 Immunity	Page 17-27 of 27

香港新界大埔工業邨大宏街10號

10 Dai Wang Street, Taipo Industrial Estate, N. T., Hong Kong

Tel: (852) 2666 1888 Fax: (852) 2664 4353 Homepage: www.hkstc.org E-mail: hkstc@hkstc.org

For full text of "Conditions of Issuance of Test Reports", please refer to overleaf or refer to the website of
STC: www.hkstc.org (the section "Application and Quotation").



香 港 標 準 及 檢 定 中 心
The Hong Kong Standards and Testing Centre Ltd.

Date: 2004-09-09
No.: HM152143

TEST REPORT

Page 3 of 27

Appendix A

LIST OF MEASUREMENT EQUIPMENT

Page A1-A3 of A3

Appendix B

Ancillary Equipment

Page B1 of B1

香港新界大埔工業邨大宏街10號

10 Dai Wang Street, Taipo Industrial Estate, N. T., Hong Kong

Tel : (852) 2666 1888 Fax: (852) 2664 4353 Homepage: www.hkstc.org E-mail: hkstc@hkstc.org

For full text of "Conditions of Issuance of Test Reports", please refer to overleaf or refer to the website of
STC: www.hkstc.org (the section "Application and Quotation").



香 港 標 準 及 檢 定 中 心
The Hong Kong Standards and Testing Centre Ltd.

Date: 2004-09-09

TEST REPORT

Page 4 of 27

No.: HM152143

1.0 General Details

1.1 Test Laboratory

The Hong Kong Standards and Testing Centre Ltd.
EMC Laboratory
10 Dai Wang Street, Taipo Industrial Estate
New Territories, Hong Kong

Telephone: 852 2666 1888

Fax: 852 2664 4353

**1.2 Applicant Details
Applicant**

Newtech Electronics Ltd.
Unit 4-6, Phase II, Chai Wan Industry City
70 Wing Tai Road, Chaiwan, Hong Kong

HKSTC Code Number for Applicant

NEE006

Manufacturer

NTL Electronics Factory
Building B22, The First Industry District,
Feng Huang Village
Fu Yong, Shenzhen, China

香港新界大埔工業邨大宏街10號

10 Dai Wang Street, Taipo Industrial Estate, N. T., Hong Kong

Tel: (852) 2666 1888 Fax: (852) 2664 4353 Homepage: www.hkstc.org E-mail: hkstc@hkstc.org

For full text of "Conditions of Issuance of Test Reports", please refer to overleaf or refer to the website of
STC. www.hkstc.org (the section "Application and Quotation").



香 港 標 準 及 檢 定 中 心
The Hong Kong Standards and Testing Centre Ltd.

Date: 2004-09-09
No.: HM152143

TEST REPORT

Page 5 of 27

1.3 Equipment Under Test [EUT]
Description of Sample

Model Name:	WEB CAMERA
Manufacturer:	NTL Electronics Factory
Brand Name:	MSN
Model Number:	MSNAR-0091
Rating:	230Va.c.

1.4 Date of Order

2004-07-29

1.5 Submitted Sample(s):

2 Samples

1.6 Test Duration

2004-08-10 to 2004-08-27

1.7 Country of Origin

CHINA

1.8 Additional Information of EUT

	Submitted	Not Available
User Manual	<input checked="" type="checkbox"/>	<input type="checkbox"/>
Part List	<input type="checkbox"/>	<input checked="" type="checkbox"/>
Circuit Diagram	<input checked="" type="checkbox"/>	<input type="checkbox"/>
Printed Circuit Board [PCB] Layout	<input checked="" type="checkbox"/>	<input type="checkbox"/>
Block Diagram	<input type="checkbox"/>	<input checked="" type="checkbox"/>

香港新界大埔工業邨大宏街10號

10 Dai Wang Street, Taiipo Industrial Estate, N. T., Hong Kong

Tel: (852) 2666 1888 Fax: (852) 2664 4353 Homepage: www.hkstc.org E-mail: hkstc@hkstc.org

For full text of "Conditions of Issuance of Test Reports", please refer to overleaf or refer to the website of
STC: www.hkstc.org (the section "Application and Quotation")



香 港 標 準 及 檢 定 中 心
The Hong Kong Standards and Testing Centre Ltd.

Date: 2004-09-09
No.: HM152143

TEST REPORT

Page 6 of 27

2.0 Technical Details

2.1 Investigations Requested

Perform ElectroMagnetic Interference [EMI] & ElectroMagnetic Susceptibility [EMS] tests

2.2 Test Standards and Results Summary Tables

Test Standards	
EN55022: 1998 +A1: 2000 +A2: 2003	Limits and methods of measurement of radio disturbance characteristics of information technology equipment.
EN55024: 1998 +A1: 2001 +A2: 2003	Information technology equipment-Immunity Characteristics – Limits and method of measurement.
EN61000-3-2: 2000	Electromagnetic compatibility, Part 3 limit. Section 2, limits for harmonic current emissions (equipment input current ≤ 16 A per phase.)
EN61000-3-3: 1995 +A1: 2001	Electromagnetic compatibility (EMC) -Part 3: Limits - Section 3: Limitation of voltage fluctuations and flicker in low-voltage supply systems for equipment with rated current ≤ 16 A per phase

香港新界大埔工業邨大宏街10號

10 Dai Wang Street, Tai Po Industrial Estate, N. T., Hong Kong

Tel : (852) 2666 1888 Fax: (852) 2664 4353 Homepage: www.hkstc.org E-mail: hkstc@hkstc.org

For full text of "Conditions of Issuance of Test Reports", please refer to overleaf or refer to the website of

STC: www.hkstc.org (the section "Application and Quotation").



香 港 標 準 及 檢 定 中 心
The Hong Kong Standards and Testing Centre Ltd.

Date: 2004-09-09
No.: HM152143

TEST REPORT

Page 7 of 27

2.2 Test Standards and Results Summary Tables

EMISSION Results Summary						
Test Condition	Test Requirement	Test Method	Class / Severity	Test Result		
				Pass	Failed	N/A
* Radiated Emission, 30MHz to 1GHz	EN55022: 1998 +A1: 2000 +A2: 2003	EN55022: 1998 +A1: 2000 +A2: 2003	Class B	<input type="checkbox"/>	<input type="checkbox"/>	<input checked="" type="checkbox"/>
Conducted Emission on AC, 150kHz to 30MHz	EN55022: 1998 +A1: 2000 +A2: 2003	EN55022: 1998 +A1: 2000 +A2: 2003	Class B	<input checked="" type="checkbox"/>	<input type="checkbox"/>	<input type="checkbox"/>
Harmonics Emissions on AC Supply	EN61000-3-2: 2000	EN61000-3-2: 2000	Class A	<input checked="" type="checkbox"/>	<input type="checkbox"/>	<input type="checkbox"/>
Voltage Fluctuations on AC Supply	EN61000-3-3: 1995 +A1: 2001	EN61000-3-3: 1995 +A1: 2001	N/A	<input checked="" type="checkbox"/>	<input type="checkbox"/>	<input type="checkbox"/>

Remark: * - Test not performed as per request by customer



香港標準及檢定中心
The Hong Kong Standards and Testing Centre Ltd.

Date: 2004-09-09

TEST REPORT

Page 8 of 27

No.: HM152143

2.2 Test Standards and Results Summary Tables

SUSCEPTIBILITY Results Summary						
Test Condition	Test Requirement	Test Method	Class / Severity	Test Result		
				Pass	Failed	N/A
Electrostatic Discharge	EN55024: 1998 +A1: 2001 +A2: 2003	IEC61000-4-2: 1995	±4.0kV Cont ±8.0kV Air	<input checked="" type="checkbox"/>	<input type="checkbox"/>	<input type="checkbox"/>
Radiated Immunity 80MHz to 1000MHz	EN55024: 1998 +A1: 2001 +A2: 2003	IEC61000-4-3: 2002 +A1: 2002	3V/m	<input checked="" type="checkbox"/>	<input type="checkbox"/>	<input type="checkbox"/>
Electrical Fast Transients on AC Supply	EN55024: 1998 +A1: 2001 +A2: 2003	IEC61000-4-4: 1995 +A1: 2000 +A2: 2001	±1.0kV	<input checked="" type="checkbox"/>	<input type="checkbox"/>	<input type="checkbox"/>
Surge Immunity on AC Supply	EN55024: 1998 +A1: 2001 +A2: 2003	IEC61000-4-5: 1995 +A1: 2001	±1.0kV ±2.0kV	<input checked="" type="checkbox"/>	<input type="checkbox"/>	<input type="checkbox"/>
Continuous RF Immunity on AC Supply	EN55024: 1998 +A1: 2001 +A2: 2003	IEC61000-4-6: 2003	3.0Vrms	<input checked="" type="checkbox"/>	<input type="checkbox"/>	<input type="checkbox"/>
Voltage Dips, Interruptions and Variations on AC Supply	EN55024: 1998 +A1: 2001 +A2: 2003	IEC61000-4-11: 2001	0%, 70% of U_T	<input checked="" type="checkbox"/>	<input type="checkbox"/>	<input type="checkbox"/>

N/A - Not Applicable

U_T - The nominal supply voltage

香港新界大埔工業邨大宏街10號

10 Dai Wang Street, Taiipo Industrial Estate, N. T., Hong Kong

Tel: (852) 2666 1888 Fax: (852) 2664 4353 Homepage: www.hkstc.org E-mail: hkstc@hkstc.org

For full text of "Conditions of Issuance of Test Reports", please refer to overleaf or refer to the website of STC: www.hkstc.org (the section "Application and Quotation").



香港標準及檢定中心
The Hong Kong Standards and Testing Centre Ltd.

Date: 2004-09-09
No.: HM152143

TEST REPORT

Page 9 of 27

3.0 Test Results

3.1 Emission

3.1.1 Conducted Emissions (150kHz to 30MHz)

Test Requirement:	EN 55022
Test Method:	EN 55022
Level:	Class B
Test Date(s):	2004-08-12
Mode of Operation:	On Mode (Connect to PC)

Test Method:

Initial measurements were performed in peak and average detection modes on the live line. Any emissions recorded within 30dB of the relevant limit lines were re-measured using quasi-peak and average detection on the live and neutral lines with the worst case recorded in the table of results. The test was performed in accordance with EN 55022.

Test Setup:

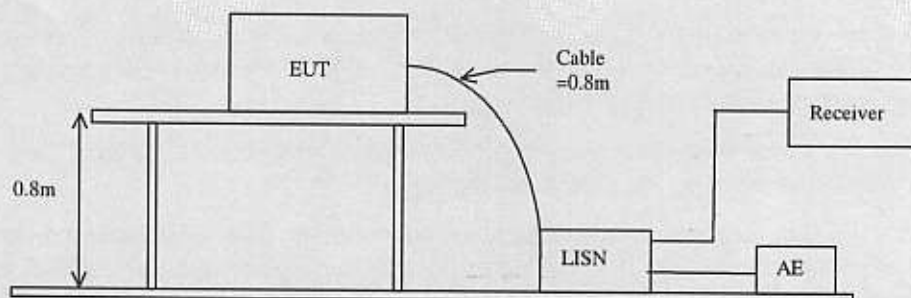

香港新界大埔工業邨大宏街10號

10 Dai Wang Street, Taipo Industrial Estate, N. T., Hong Kong

Tel: (852) 2666 1888 Fax: (852) 2664 4353 Homepage: www.hkstdc.org E-mail: hkstdc@hkstdc.org

For full text of "Conditions of Issuance of Test Reports", please refer to overleaf or refer to the website of STC: www.hkstdc.org (the section "Application and Quotation").



香港標準及檢定中心
The Hong Kong Standards and Testing Centre Ltd.

Date: 2004-09-09
No.: HM152143

TEST REPORT

Page 10 of 27

Results and limit lines for Conducted Emission:

Limits for Conducted Emission Test, please refer to limit lines (Quasi-Peak and Average) in the following diagram.

Results: Pass

Please refer to the following diagram for individual results.

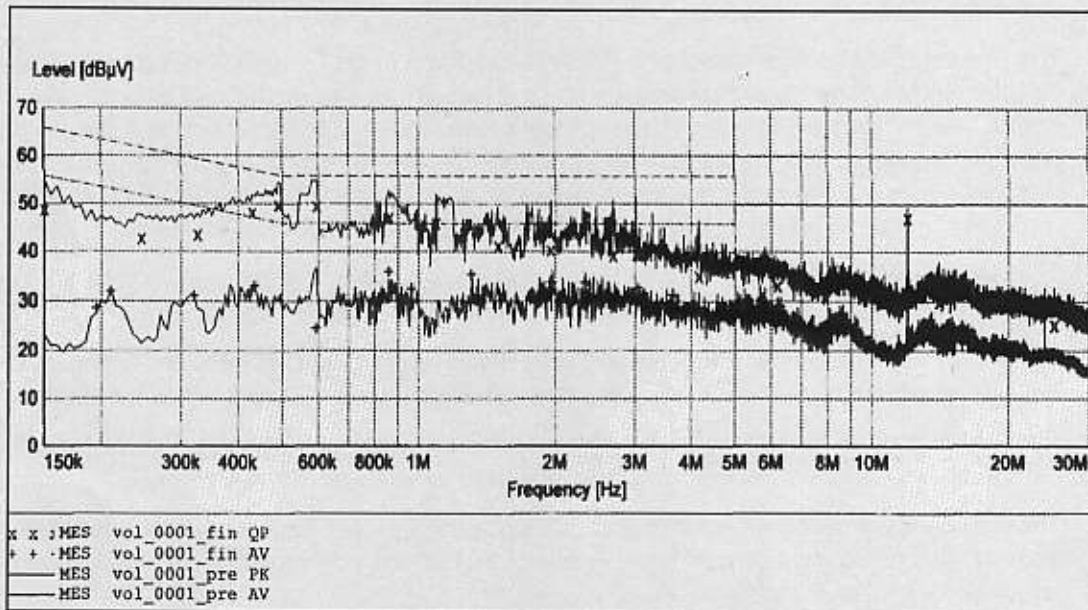

Remark:

Calculated measurement uncertainty: ± 2.8 dB



香 港 標 準 及 檢 定 中 心
The Hong Kong Standards and Testing Centre Ltd.

Date: 2004-09-09

TEST REPORT

Page 11 of 27

No.: HM152143

3.1.2 Harmonics Emissions on AC Supply

Test Requirement:	EN 61000-3-2
Test Method:	EN 61000-3-2
Level:	Class A
Test Date(s):	2004-08-10
Mode of Operation:	On Mode (measure in PC)
Input Voltage:	230Va.c.

Test Method:

The test was performed in accordance with EN 61000-3-2.

香港新界大埔工業邨大宏街10號

10 Dai Wang Street, Taipo Industrial Estate, N. T., Hong Kong

Tel: (852) 2666 1888 Fax: (852) 2664 4353 Homepage: www.hkstc.org E-mail: hkstc@hkstc.org

For full text of "Conditions of Issuance of Test Reports", please refer to overleaf or refer to the website of STC. www.hkstc.org (the section "Application and Quotation").



香港標準及檢定中心
The Hong Kong Standards and Testing Centre Ltd.

Date: 2004-09-09
No.: HM152143

TEST REPORT

Page 12 of 27

Results and limit line for Harmonics Emissions:

For limits for Harmonics Emission Test, please refer to limit line (dotted line) in the following diagram.

Results: Pass

Please refer to the following table for individual results.

Current & voltage waveforms

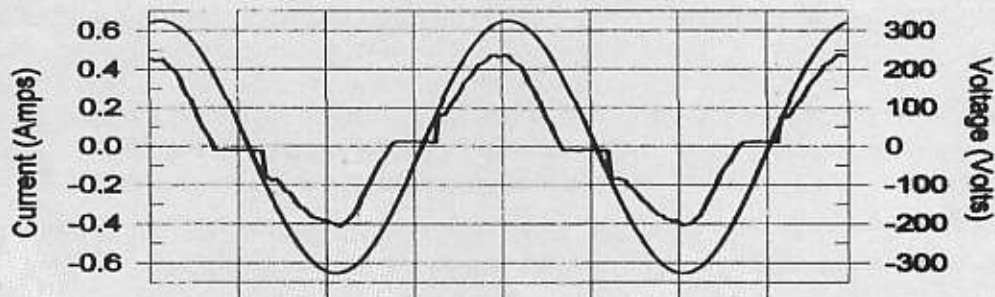

Harmonics and Class-D limit line European Limits

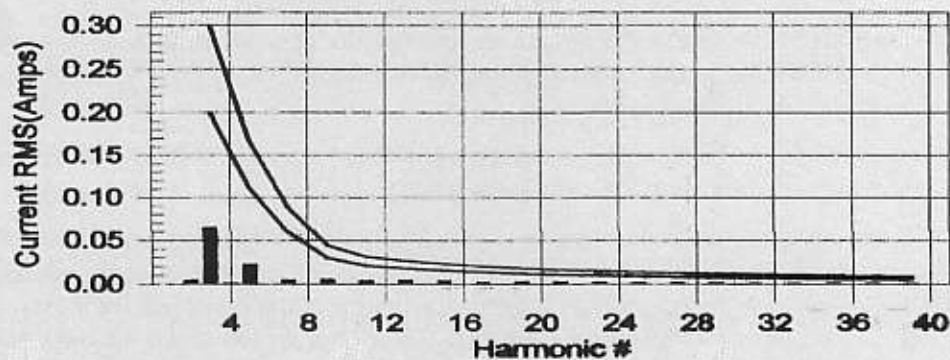

Remark:

Calculated measurement uncertainty: $\pm 1.8\text{dB}$

香港新界大埔工業邨大宏街10號

10 Dai Wang Street, Taipo Industrial Estate, N. T., Hong Kong

Tel: (852) 2666 1888 Fax: (852) 2664 4353 Homepage: www.hkstc.org E-mail: hkstc@hkstc.org

For full text of "Conditions of Issuance of Test Reports", please refer to overleaf or refer to the website of STC: www.hkstc.org (the section "Application and Quotation").



香 港 標 準 及 檢 定 中 心
The Hong Kong Standards and Testing Centre Ltd.

Date: 2004-09-09
No.: HM152143

TEST REPORT

Page 13 of 27

3.1.3 Emission for Fluctuations & Flicker

Test Requirement:	EN 61000-3-3
Test Method:	EN 61000-3-3
Level:	N/A
Test Date(s):	2004-08-10
Mode of Operation:	On Mode (measure in PC)

Test Method:

The test was performed in accordance with EN 61000-3-3.



香 港 標 準 及 檢 定 中 心
The Hong Kong Standards and Testing Centre Ltd.

Date: 2004-09-09
No.: HM152143

TEST REPORT

Page 14 of 27

Limits for Flicker:

Please refer to the result table for details.

Results: Pass

Please refer to the following table for individual results.

Maximum Occurring Levels:

Pst:	0.001	Limit =	1.0	(The Highest Short Term Flicker Value)
Plt:	0.001	Limit =	0.65	(The Highest Long Term Flicker Value)
dc(%):	0.00	Limit =	3.3%	(The Highest Relative Steady State Voltage Change (1sec))
dmax:	0.00	Limit =	4%	(The Highest Maximum Relative Voltage Change)
Tdt:	0.0	Limit =	500ms	(The Max Time (in milli-sec) that dt exceeds 3.3%)
Ut:	230.15			(EUT Test RMS Voltage)

Remark:

Calculated measurement uncertainty: $\pm 1.8\text{dB}$

香港新界大埔工業邨大宏街10號

10 Dai Wang Street, Tai Po Industrial Estate, N. T., Hong Kong

Tel: (852) 2666 1888 Fax: (852) 2664 4353 Homepage: www.hkstc.org E-mail: hkstc@hkstc.org

For full text of "Conditions of Issuance of Test Reports", please refer to overleaf or refer to the website of STC: www.hkstc.org (the section "Application and Quotation").



香 港 標 準 及 檢 定 中 心
The Hong Kong Standards and Testing Centre Ltd.

Date: 2004-09-09
No.: HM152143

TEST REPORT

Page 15 of 27

3.2 Immunity

3.2.1 Susceptibility Performance Criteria

A	Normal performance within the specification limits
B	Temporary degradation or loss of function or performance which is self-recoverable
C	Temporary degradation or loss of function or performance which requires operator intervention or system reset
D	Degradation or loss of function which is not recoverable due to damage of equipment (components) or software, or loss of data

香港新界大埔工業邨大宏街10號

10 Dai Wang Street, Taipo Industrial Estate, N. T., Hong Kong

Tel: (852) 2666 1888 Fax: (852) 2664 4353 Homepage: www.hkstc.org E-mail: hkstc@hkstc.org

For full text of "Conditions of Issuance of Test Reports", please refer to overleaf or refer to the website of STC: www.hkstc.org (the section "Application and Quotation").



Date: 2004-09-09
No.: HM152143

TEST REPORT

Page 16 of 27

3.2.2 Electrostatic Discharge

Test Requirement:	EN 55024
Test Method:	IEC 61000-4-2
Severity:	±4kV for Direct & In-Direct Contact Discharge ±8kV for Air Discharge

Performance Criterion Requirement: B

Temperature:	23.0 °C
Humidity:	40.0 %
Atmospheric Pressure:	102.0 kPa

Test Date(s): 2004-08-12

Mode of Operation: On Mode

Test Method:

The test was performed in accordance with IEC 61000-4-2.

Test Setup:

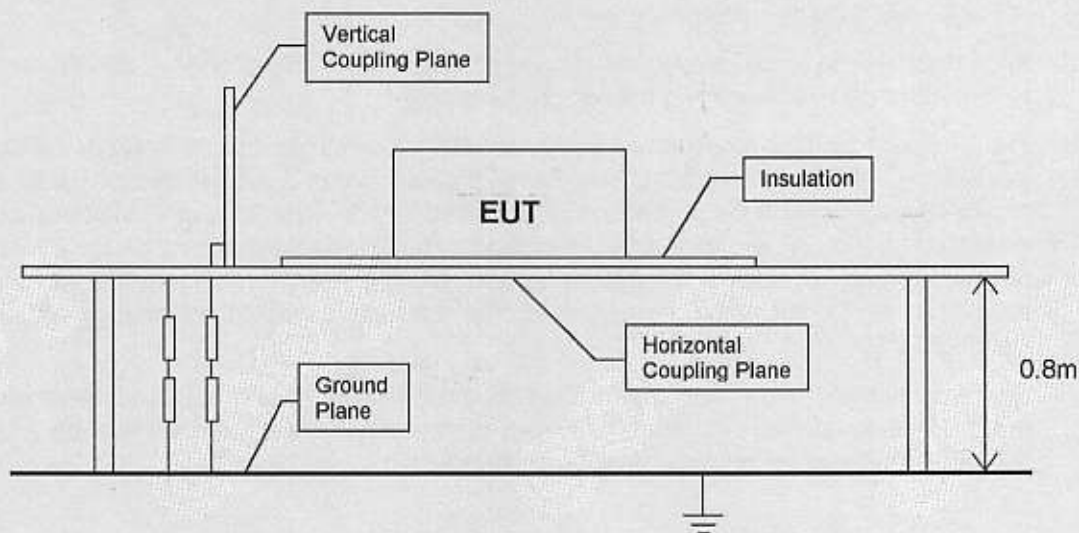

香港新界大埔工業邨大宏街10號

10 Dai Wang Street, Taipo Industrial Estate, N. T., Hong Kong

Tel: (852) 2666 1888 Fax: (852) 2664 4353 Homepage: www.hkstc.org E-mail: hkstc@hkstc.org

For full text of "Conditions of Issuance of Test Reports", please refer to overleaf or refer to the website of STC: www.hkstc.org (the section "Application and Quotation").



香港標準及檢定中心
The Hong Kong Standards and Testing Centre Ltd.

Date: 2004-09-09
No.: HM152143

TEST REPORT

Page 17 of 27

Severity Levels for Electrostatic Discharge:

Level	Test Voltage Direct & In-Direct Contact Discharge	Test Voltage Air Discharge
1	±2kV	±2kV
2	±4kV	±4kV
3	±6kV	±8kV
4	±8kV	±15kV

Results: Pass

Please refer to the following table for individual results.

Location	Discharge Method	Test Voltage	Individual Results	
			Pass	Failed
HCP [Horizontal Coupling Plane]	Indirect Contact	±4kV	<input checked="" type="checkbox"/>	<input type="checkbox"/>
VCP [Vertical Coupling Plane]	Indirect Contact	±4kV	<input checked="" type="checkbox"/>	<input type="checkbox"/>
3 Screws	Direct Contact	±4kV	<input checked="" type="checkbox"/>	<input type="checkbox"/>
Cable	Air	±8kV	<input checked="" type="checkbox"/>	<input type="checkbox"/>
Enclosure	Air	±8kV	<input checked="" type="checkbox"/>	<input type="checkbox"/>

Remark:

Calculated measurement uncertainty: ±0.4kV

香港新界大埔工業邨大宏街10號

10 Dai Wang Street, Taipo Industrial Estate, N. T., Hong Kong

Tel: (852) 2666 1888 Fax: (852) 2664 4353 Homepage: www.hkstdc.org E-mail: hkstdc@hkstdc.org

For full text of "Conditions of Issuance of Test Reports", please refer to overleaf or refer to the website of STC, www.hkstdc.org (the section "Application and Quotation").



Date: 2004-09-09
No.: HM152143

TEST REPORT

Page 18 of 27

3.2.3 Radiated Immunity [80MHz to 1000MHz]

Test Requirement:	EN 55024
Test Method:	IEC 61000-4-3
Severity:	Level 2 [3V/m]
Modulation:	80% AM

Performance Criterion Requirement: A

Temperature:	22.0 °C
Humidity:	40.0 %
Atmospheric Pressure:	101.8 kPa

Test Date(s): 2004-08-12

Mode of Operation: On Mode

Test Method:

The test was performed in accordance with IEC 61000-4-3.

Test Setup:

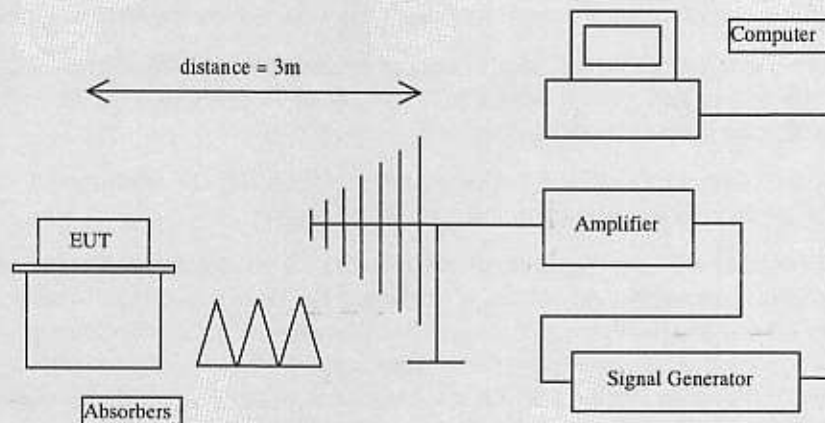

香港新界大埔工業邨大宏街10號

10 Dai Wang Street, Taipo Industrial Estate, N. T., Hong Kong

Tel: (852) 2666 1888 Fax: (852) 2664 4353 Homepage: www.hkstc.org E-mail: hkstc@hkstc.org

For full text of "Conditions of Issuance of Test Reports", please refer to overleaf or refer to the website of STC: www.hkstc.org (the section "Application and Quotation").



香港標準及檢定中心
The Hong Kong Standards and Testing Centre Ltd.

Date: 2004-09-09
No.: HM152143

TEST REPORT

Page 19 of 27

Severity Levels for Radiated Immunity:

Level	Field Strength [V/m]
1	1
2	3
3	10

Results: Pass

Please refer to the following table for individual results.

Frequency (MHz)	Face	Polarity	Level (V/m)	Dwell Time (s)	Sweep rate (%)	Individual Results	
						Pass	Failed
80-1000	0°	Horizontal	3	3	1	<input checked="" type="checkbox"/>	<input type="checkbox"/>
80-1000	90°	Horizontal	3	3	1	<input checked="" type="checkbox"/>	<input type="checkbox"/>
80-1000	180°	Horizontal	3	3	1	<input checked="" type="checkbox"/>	<input type="checkbox"/>
80-1000	270°	Horizontal	3	3	1	<input checked="" type="checkbox"/>	<input type="checkbox"/>
80-1000	0°	Vertical	3	3	1	<input checked="" type="checkbox"/>	<input type="checkbox"/>
80-1000	90°	Vertical	3	3	1	<input checked="" type="checkbox"/>	<input type="checkbox"/>
80-1000	180°	Vertical	3	3	1	<input checked="" type="checkbox"/>	<input type="checkbox"/>
80-1000	270°	Vertical	3	3	1	<input checked="" type="checkbox"/>	<input type="checkbox"/>

Remark:

Calculated measurement uncertainty: -1.3V/m (Negative Value), +3.7V/m (Positive Value)



Date: 2004-09-09
No.: HM152143

TEST REPORT

Page 20 of 27

3.2.4 Electrical Fast Transients on AC Supply

Test Requirement:	EN 55024
Test Method:	IEC 61000-4-4
Severity:	Level 2 on AC [± 1 kV]

Performance Criterion Requirement: B

Temperature:	23.0 °C
Humidity:	41.0 %
Atmospheric Pressure:	101.8 kPa

Test Date(s): 2004-08-12

Mode of Operation: On Mode

Test Method:

The test was performed in accordance with IEC 61000-4-4.

Test Setup:

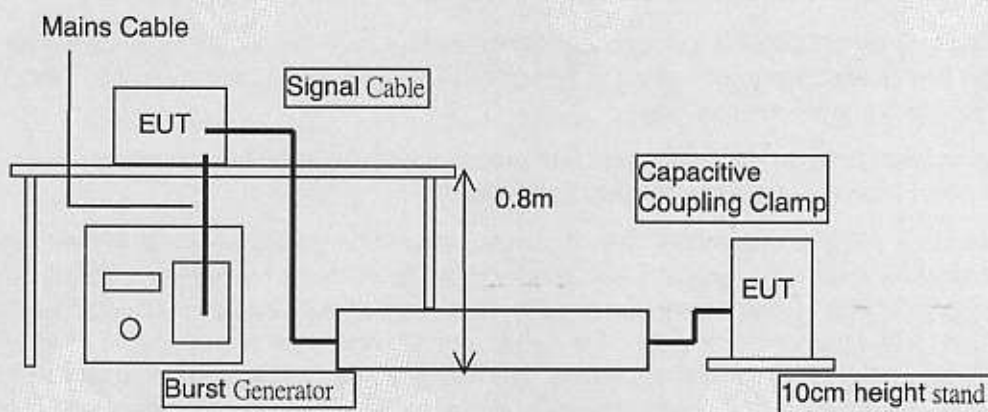

香港新界大埔工業邨大宏街10號

10 Dai Wang Street, Taipo Industrial Estate, N. T., Hong Kong

Tel: (852) 2666 1888 Fax: (852) 2664 4353 Homepage: www.hkstc.org E-mail: hkstc@hkstc.org

For full text of "Conditions of Issuance of Test Reports", please refer to overleaf or refer to the website of STC. www.hkstc.org (the section "Application and Quotation").



香港標準及檢定中心
The Hong Kong Standards and Testing Centre Ltd.

Date: 2004-09-09
No.: HM152143

TEST REPORT

Page 21 of 27

Severity Levels for Electrical Fast Transient:

Level	On power supply port, PE		On I/O (Input/Output) signal, data and control ports	
	Voltage peak [kV]	Repetition rate [kHz]	Voltage peak [kV]	Repetition rate [kHz]
1	0.5	5.0	0.25	5.0
2	1.0	5.0	0.50	5.0
3	2.0	5.0	1.00	5.0
4	4.0	2.5	2.00	5.0
x	Customer Requirement		Customer Requirement	

Results: Pass

Please refer to the following table for individual results.

Conductor	Polarity & Level	Duration/Polarity (s)	Individual Results	
			Pass	Failed
Live	±1kV	120	<input checked="" type="checkbox"/>	<input type="checkbox"/>
Neutral	±1kV	120	<input checked="" type="checkbox"/>	<input type="checkbox"/>
Earth	±1kV	120	<input checked="" type="checkbox"/>	<input type="checkbox"/>

Remark:

Calculated measurement uncertainty: ±0.14kV



Date: 2004-09-09
No.: HM152143

TEST REPORT

Page 22 of 27

3.2.5 Surge Immunity on AC Supply

Test Requirement:	EN 55024
Test Method:	IEC 61000-4-5
Severity:	Level 2 - $\pm 1.0\text{kV}$ (between live & neutral) Level 3 - $\pm 2.0\text{kV}$ (between live & earth) Level 3 - $\pm 2.0\text{kV}$ (between earth & neutral)

Performance Criterion Requirement: B

Temperature:	22.0 °C
Humidity:	40.0 %
Atmospheric Pressure:	101.8 kPa

Test Date(s): 2004-08-12

Mode of Operation: On Mode

Test Method:

The test was performed in accordance with IEC 61000-4-5.

Test Setup:

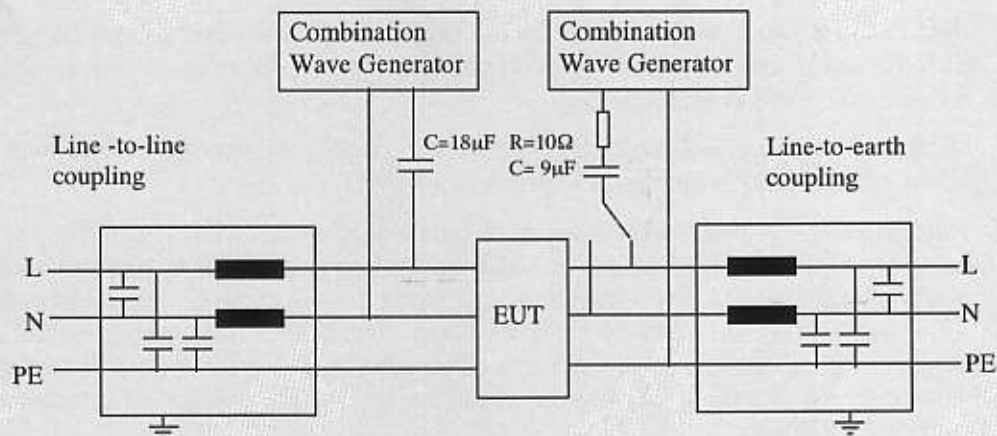

香港新界大埔工業邨大宏街10號

10 Dai Wang Street, Taipo Industrial Estate, N. T., Hong Kong

Tel: (852) 2666 1888 Fax: (852) 2664 4353 Homepage: www.hkstc.org E-mail: hkstc@hkstc.org

For full text of "Conditions of Issuance of Test Reports", please refer to overleaf or refer to the website of STC: www.hkstc.org (the section "Application and Quotation").



香港標準及檢定中心
The Hong Kong Standards and Testing Centre Ltd.

Date: 2004-09-09
No.: HM152143

TEST REPORT

Page 23 of 27

Severity Levels for Surge Immunity:

Level	Open-circuit test voltage $\pm 10\%$
1	0.5 kV
2	1.0 kV
3	2.0 kV
4	4.0 kV

Results: Pass

Please refer to the following table for individual results.

Conductor	Level & Polarity	No. of Surge	Phase Angle	Surge Interval	Individual Results	
					Pass	Failed
Live - Neutral	$\pm 1.0\text{kV}$	5	0°	60s	<input checked="" type="checkbox"/>	<input type="checkbox"/>
			90°		<input checked="" type="checkbox"/>	<input type="checkbox"/>
			180°		<input checked="" type="checkbox"/>	<input type="checkbox"/>
			270°		<input checked="" type="checkbox"/>	<input type="checkbox"/>
Live - Earth	$\pm 2.0\text{kV}$	5	0°	60s	<input checked="" type="checkbox"/>	<input type="checkbox"/>
			90°		<input checked="" type="checkbox"/>	<input type="checkbox"/>
			180°		<input checked="" type="checkbox"/>	<input type="checkbox"/>
			270°		<input checked="" type="checkbox"/>	<input type="checkbox"/>
Earth - Neutral	$\pm 2.0\text{kV}$	5	0°	60s	<input checked="" type="checkbox"/>	<input type="checkbox"/>
			90°		<input checked="" type="checkbox"/>	<input type="checkbox"/>
			180°		<input checked="" type="checkbox"/>	<input type="checkbox"/>
			270°		<input checked="" type="checkbox"/>	<input type="checkbox"/>

Remark:

Calculated measurement uncertainty: $\pm 0.23\text{kV}$



香港標準及檢定中心
The Hong Kong Standards and Testing Centre Ltd.

Date: 2004-09-09
No.: HM152143

TEST REPORT

Page 24 of 27

3.2.6 Continuous RF Immunity on AC Supply (150kHz to 80MHz)

Test Requirement:	EN 55024
Test Method:	IEC 61000-4-6
Severity:	Level 2 - 3Vrms(emf) with 80% 1kHz AM

Performance Criterion Requirement: A

Temperature:	22.0 °C
Humidity:	40.0 %
Atmospheric Pressure:	102.0 kPa

Test Date(s): 2004-08-12

Mode of Operation: On Mode

Test Method:

The test was performed in accordance with IEC 61000-4-6.

Test Setup:

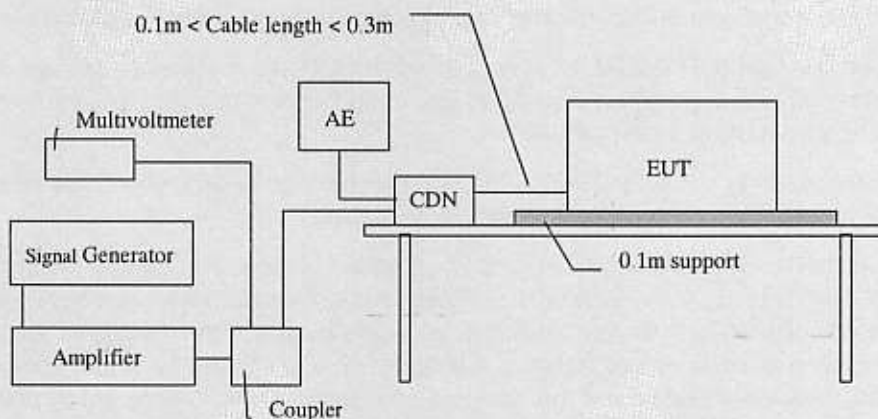

香港新界大埔工業邨大宏街10號

10 Dai Wang Street, Taipo Industrial Estate, N. T., Hong Kong

Tel: (852) 2666 1888 Fax: (852) 2664 4353 Homepage: www.hkstc.org E-mail: hkstc@hkstc.org

For full text of "Conditions of Issuance of Test Reports", please refer to overleaf or refer to the website of
STC: www.hkstc.org (the section "Application and Quotation").



香港標準及檢定中心
The Hong Kong Standards and Testing Centre Ltd.

Date: 2004-09-09
No.: HM152143

TEST REPORT

Page 25 of 27

Severity Levels for Continuous RF Immunity:

Frequency range 150kHz - 80MHz		
Level	Voltage level (emf)	
	U_0 [dB(μ V)]	U_0 [V]
1	120	1
2	130	3
3	140	10

Results: Pass

Please refer to the following table for individual results.

Frequency (MHz)	Level (V/m)	Dwell Time (s)	Sweep rate (%)	Individual Results	
				Pass	Failed
150kHz - 80MHz	3.0Vrms	3	1	<input checked="" type="checkbox"/>	<input type="checkbox"/>

Remark:

Calculated measurement uncertainty: ± 2.3 dB



香 港 標 準 及 檢 定 中 心
The Hong Kong Standards and Testing Centre Ltd.

Date: 2004-09-09
No.: HM152143

TEST REPORT

Page 26 of 27

3.2.7 Voltage Dips, Interruptions and Variations on AC Supply

Test Requirement: EN 55024
Test Method: IEC 61000-4-11
Severity: [0, 70]% of U_T

Performance Criterion Requirement: B for 0% of U_T for 0.5 period
C for other specifications

Temperature: 22.0 °C
Humidity: 43.0 %
Atmospheric Pressure: 101.8 kPa

Test Date(s): 2004-08-12

Mode of Operation: On Mode

Test Method:

The test was performed in accordance with IEC 61000-4-11.



香港標準及檢定中心
The Hong Kong Standards and Testing Centre Ltd.

Date: 2004-09-09

TEST REPORT

Page 27 of 27

No.: HM152143

Severity Levels for voltage dips, short interruptions and voltage variations immunity:

Level	Voltage dip and short interruptions	Duration (period)
0	100	250
0	100	0.5
70	30	25

Results: Pass

Please refer to the following table for individual results.

Phase	Test Level (% of U_T)	Duration (period)	Individual Results	
			Pass	Failed
0° followed by 180°	0	250	<input checked="" type="checkbox"/>	<input type="checkbox"/>
*0° followed by 180°	0	0.5	<input checked="" type="checkbox"/>	<input type="checkbox"/>
0° followed by 180°	70	25	<input checked="" type="checkbox"/>	<input type="checkbox"/>

Remarks:

- *- Temporary degradation or loss of function or performance which requires operator intervention or system reset.

Calculated measurement uncertainty: $\pm 30V$

U_T - The nominal supply voltage

End of Document

香港新界大埔工業邨大宏街10號

10 Dai Wang Street, Tai Po Industrial Estate, N. T., Hong Kong

Tel: (852) 2666 1888 Fax: (852) 2664 4353 Homepage: www.hkstc.org E-mail: hkstc@hkstc.org

For full text of "Conditions of Issuance of Test Reports", please refer to overleaf or refer to the website of

STC: www.hkstc.org (the section "Application and Quotation").



香港標準及檢定中心
The Hong Kong Standards and Testing Centre Ltd.

Date: 2004-09-09

TEST REPORT
APPENDIX A

Page A1 of A3

No.: HM152143

LIST OF MEASUREMENT EQUIPMENT

Radiated Emission

EQP NO.	DESCRIPTION	MANUFACTURER	MODEL NO.	SERIAL NO.	LAST CAL
EM007	SPECTRUM ANALYZER	HEWLETT PACKARD	HP85660B	3144A21192	15/06/04
EM008	SPECTRUM ANALYZER DISPLAY	HEWLETT PACKARD	HP85662A	3144A20514	15/06/04
EM009	QUASI PEAK ADAPTOR	HEWLETT PACKARD	HP85650A	3303A01702	15/06/04
EM010	RF PRESELECTOR	HEWLETT PACKARD	HP85685A	3221A01410	15/06/04
EM011	ATTENUATOR/SWITCH	HEWLETT PACKARD	HP11713A	2508A10595	15/06/04
EM012	PRE-AMPLIFIER	HEWLETT PACKARD	HP8449B	3008A00262	15/06/04
EM013	CONTROLLER (COMPUTER), COLOR MONITOR, KEYBOARD & MOUSE FLOPPY DRIVE	HEWLETT PACKARD HEWLETT PACKARD HEWLETT PACKARD	HP9000 HP A1097C HP9133L	6226A60314 3151J39517 2623A02468	15/06/04
EM020	HORN ANTENNA	EMCO	3115	4032	30/07/03
EM022	LOOP ANTENNA	EMCO	6502	1189-2424	19/04/03
EM072	SIGNAL GENERATOR	HEWLETT PACKARD	8640B	1948A11892	N/A
EM083	HKSTC OPEN AREA TEST SITE	HKSTC	N/A	N/A	08/02/03
EM131	PORTABLE SPECTRUM ANALYSER	HEWLETT PACKARD	8595EM	3710A00155	13/01/04
EM145	EMI TEST RECEIVER	R & S	ESCS 30	830245/021	02/08/03
EM194	BICONILOG ANTENNA	EMCO	3142B	1795	14/05/02
EM195	ANTENNA POSITIONING MAST	EMCO	2075	2368	N/A
EM196	MULTI-DEVICE CONTROLLER	EMCO	2090	1662	N/A

Line Conducted

EQP NO.	DESCRIPTION	MANUFACTURER	MODEL NO.	SERIAL NO.	LAST CAL
EM078	VARIAC	SHANGHAI VOLTAGE	TDGC-3/0.5	N/A	CM
EM081	SMALL SCREENED ROOM	MIKO INST HK	N/A	N/A	17/10/03
EM119	LISN	R & S	ESH3-Z5	0831.5518.52	01/10/02
EM127	ISOLATION TRANSFORMER 220 TO 300	WING SUN	N/A	N/A	CM
EM142	PULSES LIMITER	R & S	ESH3Z2	357.8810.52	07/07/03
EM181	EMI TEST RECEIVER	R & S	ESIB7	100072	06/01/04
EM154	SHIELDING ROOM	SIEMENA MATSUSHITA COMPONENTS	N/A	803-740-057- 99A	17/10/03
EM197	LISN	EMCO	4825/2	1193	08/04/03

Harmonics & Flicker

EQP NO.	DESCRIPTION	MANUFACTURER	MODEL NO.	SERIAL NO.	LAST CAL
EM040	POWER AMPLIFIER	KIKUSUI	PCR 4000L	13080111	N/A
EM037	CONTROL CENTER (HARM & FLKR)	KEYTEK	ECAT	9510535	15/07/03
EM038	CONV. FIBER OPTIC - RS232 FOR ECAT	KEYTEK	FC-11	9510217	CM
EM122	COMPUTER FOR ECAT SYSTEM, INC MONITOR, KEYBOARD & MOUSE	AST	ADVENTURE 2000	247GP400074 6	N/A

香港新界大埔工業邨大宏街10號

10 Dai Wang Street, Taipo Industrial Estate, N. T., Hong Kong

Tel: (852) 2666 1888 Fax: (852) 2664 4353 Homepage: www.hkstdc.org E-mail: hkstdc@hkstdc.org

For full text of "Conditions of Issuance of Test Reports", please refer to overleaf or refer to the website of
STC: www.hkstdc.org (the section "Application and Quotation").



香 港 標 準 及 檢 定 中 心
The Hong Kong Standards and Testing Centre Ltd.

Date: 2004-09-09

TEST REPORT
APPENDIX A

Page A2 of A3

No.: HM152143

Electro-Static Discharge

EQP NO.	DESCRIPTION	MANUFACTURER	MODEL NO.	SERIAL NO.	LAST CAL
EM051	THERMOHYGROMETER	SATO	SIGMA II NSII-Q	011010	09/10/03
EM102	VERTICAL COUPLING PLANE	HKSTC	N/A	N/A	CM
EM103	HORIZONTAL COUPLING PLANE	HKSTC	N/A	N/A	CM
EM086	QUARTZ BAROMETER	SATO	SIGMA II	35042	29/08/03
EM080	LARGE SCREENED ROOM	MIKO INST HK	N/A	N/A	17/10/03
EM158	ESD SIMULATOR	NOISEKEN	ESS-00L(A) TC-815P	2199C02603 2199C02569	30/09/03
EN178	CONDUCTED IMMUNITY TEST SYSTEM	SCHAFFNER	BEST EMC	200126-009SC	03/12/03

Radiated Immunity

EQP NO.	DESCRIPTION	MANUFACTURER	MODEL NO.	SERIAL NO.	LAST CAL
EM174	ANTENNA	EMCO	3142B	1671	07/08/03
EM031	ELECTRIC FIELD PROBE	HOLADAY	HE-4433-HSE	90590	26/08/03
EM035	POWER AMPLIFIER	KALMUS	7100LC-CE	7468-1	CM
EM058	FIBRE-OPTIC LEAD & DRUM	PPM	N/A	029	CM
EM059	COLOUR MONITOR FOR CCTV	FOR-TEC	N/A	VM140006585	CM
EM079	HUMIDITY & TEMPERATURE METER	RS	RS204072	998440	12/01/03
EM082	ANECHOIC CHAMBER	FELJAS & MASSON	N/A	N/A	19/09/03
EM086	QUARTZ BAROMETER	SATO	SIGMA II	35042	29/08/03
EM199	SIGNAL GENERATOR	R & S	SML02	100681	06/03/03
EM200	DUAL CHANNEL POWER METER	R & S	NRVD	100592	22/11/02
EM201	10V INSERTION UNIT	R & S	URV5-ZL	100089	20/11/02
EM202	10V INSERTION UNIT	R & S	URV5-ZL	100088	21/11/02
EM203	POWER AMP.	BONN	BLMA0820-50	025257	N/A
EM205	THERNO-HYGRO-WETTERSTATION	MIT FUNKGESTEWETER ZERTANZEIGE	N/A	N/A	28/11/03
EM206	ELECTRIC FIELD PROBE	EMCO	HI-6005	491198-48	21/02/03

Electrical Fast Transients

EQP NO.	DESCRIPTION	MANUFACTURER	MODEL NO.	SERIAL NO.	LAST CAL
EM047	COUPLING CLAMP	SCHAFFNER	CDN 126	0360	CM
EM048	FAST TRANSIENT GENERATOR	SCHAFFNER	NSG2025	1330	13/01/03
EM051	THERMOHYGROMETER	SATO	SIGMA II NSII-Q	011010	09/10/03
EM077	VARIAC	SHANGHAI VOLTAGE	TDGC-3/0.5	15839	CM
EM086	QUARTZ BAROMETER	SATO	SIGMA II	35042	29/08/03
EM080	LARGE SCREENED ROOM	MIKO INST HK	N/A	N/A	18/10/02
EN178	CONDUCTED IMMUNITY TEST SYSTEM	SCHAFFNER	BEST EMC	200126-009SC	03/12/03

香港新界大埔工業邨大宏街10號

10 Dai Wang Street, Taipo Industrial Estate, N.T., Hong Kong

Tel: (852) 2666 1888 Fax: (852) 2664 4353 Homepage: www.hkstc.org E-mail: hkstc@hkstc.org

For full text of "Conditions of Issuance of Test Reports", please refer to overleaf or refer to the website of

STC: www.hkstc.org (the section "Application and Quotation")



香港標準及檢定中心
The Hong Kong Standards and Testing Centre Ltd.

Date: 2004-09-09

TEST REPORT
APPENDIX A

Page A3 of A3

No.: HM152143

Conducted RF Immunity

EQP NO.	DESCRIPTION	MANUFACTURER	MODEL NO.	SERIAL NO.	LAST CAL
EM042	10V INSERTION UNIT	R&S	URV5-Z2	842558/023	18/09/03
EM043	10V INSERTION UNIT	R&S	URV5-Z2	842558/024	18/09/03
EM045	POWER METER	R&S	NRVD	843246/028	18/09/03
EM095	RF MILLIVOLTMETER	R&S	NRV3	871061/232	18/09/03
EM097	10V INSERTION UNIT	R&S	URV-22	831040/157	CM
EM104	DIRECTIONAL COUPLER	AR	DC3010	20812	CM
EM105	AMPLIFIER	AR	75A250	20875	CM
EM108	50 OHM TERMINATION	WEINSHELL	1424-4	16142	CM
EM110	6DB PAD	WEINSHELL	33-06-34	BD4072	07/07/03
EM113	CDN M2	MEB	M2-801	12100	04/07/03
EM114	CDN M3	MEB	M3-801	12891	04/07/03
EM121	SIGNAL GENERATOR	R&S	SMT 02	1039.2000.02	17/07/03
EM086	QUARTZ BAROMETER	SATO	SIGMA II	35042	29/08/03
EM051	THERMOHYGROMETER	SATO	SIGMA II NSII-Q	011010	09/10/03
EM080	LARGE SCREENED ROOM	MIKO INST HK	N/A	N/A	17/10/03

Surge Immunity

EQP NO.	DESCRIPTION	MANUFACTURER	MODEL NO.	SERIAL NO.	LAST CAL
EM026	COMPUTER FOR DIPS & SURGE GENERATOR	AST	PREMIUM 2 486/33	N/A	CM
EM051	THERMOHYGROMETER	SATO	SIGMA II	011010	09/10/03
EM086	QUARTZ BAROMETER	SATO	SIGMA II	35042	29/08/03
EM115	DIPS & SURGE GENERATOR	EMC PARTNER	DIPSRG51	TRA1000-202	19/03/03
EM080	LARGE SCREENED ROOM	MIKO INST HK	N/A	N/A	17/10/03

Voltage Dropouts

EQP NO.	DESCRIPTION	MANUFACTURER	MODEL NO.	SERIAL NO.	LAST CAL
EM122	COMPUTER FOR ECAT SYSTEM, INC MONITOR, KEYBOARD & MOUSE	AST	ADVENTURE 2000	247GP4000746	N/A
EM037	CONTROL CENTER (HARM & FLKR)	KEY TEK	ECAT	9510535	15/07/03
EM038	CONV, FIBER OPTIC - RS232 FOR ECAT	KEYTEK	FC-11	9510217	CM
EM040	POWER AMPLIFIER	KIKUSUI	PCR 4000L	13080111	N/A
EN178	CONDUCTED IMMUNITY TEST SYSTEM	SCHAFFNER	BEST EMC	200126-009SC	03/12/03

Remarks:-

CM Corrective Maintenance
N/A Not Applicable or Not Available
TBD To Be Determined

香港新界大埔工業邨大宏街10號

10 Dai Wang Street, Taipo Industrial Estate, N.T., Hong Kong

Tel : (852) 2666 1888 Fax: (852) 2664 4353 Homepage: www.hkstdc.org E-mail: hkstdc@hkstdc.org

For full text of "Conditions of Issuance of Test Reports", please refer to overleaf or refer to the website of

STC: www.hkstdc.org (the section "Application and Quotation").



香 港 標 準 及 檢 定 中 心
The Hong Kong Standards and Testing Centre Ltd.

Date: 2004-09-09

TEST REPORT
APPENDIX B

Page B1 of B1

No.: HM152143

ANCILLARY EQUIPMENT

ITEM NO.	DESCRIPTION	MODEL NO.	FCC ID	REMARK
1	DELL COMPUTER	DMC	N/A	N/A
2	DELL AVGA MONITOR	E551C	ARSCM356N	RESOLUTION:800x600(DURING TESTING) 1.0M UNSHIEDED POWER CORD CONNECTED TO THE COMPUTER 2.8M SHIELED CABLE CONNECTED TO THE COMPUTER
3	DELL KEYBOARD	SK-8110	N/A	1.8M SHIEDED COILED CABLE CONNECTED TO THE COMPUTER
4	DELL MOUSE	N/A	N/A	2.4M UNSHIEDED CABLE CONNECTED TO THE COMPUTER
5	PARALLEL PRINTER	DMP3000	DE2850CDMP3000	1.8M UNSHIEDED POWER CORD 2.8M SHIEDED CABLE (BUNDLED TO 1M) CONNECTED TO THE COMPUTER

香港新界大埔工業邨大宏街10號

10 Dai Wang Street, Taipo Industrial Estate, N. T., Hong Kong

Tel: (852) 2666 1888 Fax: (852) 2664 4353 Homepage: www.hkstc.org E-mail: hkstc@hkstc.org

For full text of "Conditions of Issuance of Test Reports", please refer to overleaf or refer to the website of STC. www.hkstc.org (the section "Application and Quotation").



No 198 Kezhu Road, Science Town Economic & Technology Development
District Guangzhou, China 510663

Telephone +86 (0) 20 82155555
Fax +86 (0) 20 82075059
Email sgs_internet_operations@sgs.com

Report No.: GLEMO060300519ITE
Page: 1 of 13

TEST REPORT

Application No.: GLEMO060300519IT
Applicant: ISS MANUFACTURING LTD.
Equipment Under Test (EUT):
EUT Name: HEADSET WITH MICROPHONE, AUDIO SWITCH
Item No.: SPRO5001, SPRO5002, SPRO-5003
Serial No.: Not supplied by client
Standards: EN 61000-6-3 : 2001+A11:2004 & EN 61000-6-1 : 2001
Date of Receipt: 16 March 2006
Date of Test: N/A
Date of Issue: 20 March 2006

Test Result :	PASS*
----------------------	--------------

* The EUT complies with the standards specified above as the product is under the EMC directive. Please refer to section 2 of this report for further details.

The CE mark as shown below can be used, under the responsibility of the manufacturer, after completion of an EC Declaration of Conformity and compliance with all relevant EC Directives



Jeff Zhao
Manager



This report refers to the General Conditions for Inspection and Testing Services, printed overleaf
This report details the results of the testing carried out on one sample. The results contained in this test report do not relate to other samples of the same product and does not permit the use of the SGS PRODUCT CERTIFICATION MARK. The manufacturer should ensure that all products in series production are in conformity with the product sample detailed in this report.
This report may only be reproduced and distributed in full. If the product in this report is used in any configuration other than that detailed in the report, the manufacturer must ensure the new system complies with all relevant standards. Any mention of SGS International Electrical Approvals or testing done by SGS International Electrical Approvals in connection with, distribution or use of the product described in this report must be approved by SGS International Electrical Approvals in writing.
The report must not be used by the client to claim product certification, approval, or endorsement by NVLAP, NIST, or any agency of the federal government.
All test results in this report can be traceable to National or International Standards.

2 Test Summary

Test	Test Requirement	Test Method	Class / Severity	Result
Emission	EN 61000-6-3 2001 +A11 2004	N/A	Clause 8 of EN 61000-6-3	N/A
Immunity	EN 61000-6-1 2001	N/A	Clause 8 of EN 61000-6-1	N/A

N/A not applicable Please refer to Section 5 & Section 6 for further details

3 Contents

	Page
1 COVER PAGE.....	1
2 TEST SUMMARY	2
3 CONTENTS.....	3
4 GENERAL INFORMATION	4
4 1 CLIENT INFORMATION	4
4 2 GENERAL DESCRIPTION OF E U T	4
4 3 DETAILS OF E U T	4
4 4 DESCRIPTION OF SUPPORT UNITS	4
4 5 STANDARDS APPLICABLE FOR TESTING	4
4 6 TEST LOCATION	5
4 7 TEST FACILITY	6
4 8 DEVIATION FROM STANDARDS	6
4 9 ABNORMALITIES FROM STANDARD CONDITIONS	6
4 10 MONITORING OF EUT FOR ALL IMMUNITY TEST	6
5 EMISSION TEST RESULTS.....	7
6 IMMUNITY TEST RESULTS	7
7 PHOTOGRAPHS – EUT CONSTRUCTIONAL DETAILS.....	8-13

4 General Information

4.1 Client Information

Applicant ISS MANUFACTURING LTD
Address of Applicant UNIT 604-606, 6/F, PHASE II, CHAI WAN INDUSTRIAL CITY, 70 WING TAI ROAD, CHAI WAN, HONGKONG

4.2 General Description of E.U.T.

EUT Name HEADSET WITH MICROPHONE, AUDIO SWITCH
Item No SPRO5001, SPRO5002, SPRO-5003
Serial No Not supplied by client

4.3 Details of E.U.T.

Power Supply - N/A-
Power Cord - N/A-

4.4 Description of Support Units

N/A

4.5 Standards Applicable for Testing

The customer requested EMC tests for a HEADSET WITH MICROPHONE, AUDIO SWITCH
The standards used were EN 61000-6-3 (Emissions) & EN 61000-6-1 (Immunity)

Table 1 : Tests Carried Out Under EN 61000-6-3:2001

Standard	Status
EN 55022 1998+A1 2000+A2 2003 Radiated Emissions	×
EN 55022 1998+A1 2000+A2 2003 Conducted Emissions on AC	×
EN 61000-3-2 2000 Harmonic Emissions on AC	×
EN 61000-3-3 1995 + A1 2001 Flicker Emissions on AC	×
EN 55014-1 2000 + A1 2001+A2 2002 Discontinuous Emissions on AC	×

× Indicates that the test is not applicable

Note The EUT contains no electronics at all and hence no tests need to be performed according to standard EN 61000-6-3

Table 2 : Tests Carried Out Under EN 61000-6-1:2001

Standard	Status
EN 61000-4-2 1995 + A1 1998+ A2 2001 Electro-static discharge	×
EN 61000-4-3 2002+A1 2002 Radio frequency EM fields (80MHz to 1GHz)	×
EN 61000-4-4 1995+A1 2001+A2 2001 Fast transients	×
EN 61000-4-5 1995 +A1 2001 Surges	×
EN 61000-4-6 1996+A1 2001 Radio frequency continuous conducted (150kHz to 80MHz)	×
EN 61000-4-8 1993+A1 2001 Power-frequency magnetic field (50Hz)	×
EN 61000-4-11 1994+A1 2001 Voltage dips & interruptions	×

× Indicates that the test is not applicable

Note The EUT contains no electronics at all and hence no tests need to be performed according to standard EN 61000-6-1

4.6 Test Location

All tests (if necessary) were performed at

SGS-CSTC Standards Technical Services Co., Ltd., Guangzhou EMC Laboratory, No 198 Kezhu Road, Science Town Economic & Technology Development District Guangzhou, China 510663

Tel +86 20 82155555 Fax +86 20 82075059

No tests were sub-contracted

4.7 Test Facility

The test facility is recognized, certified, or accredited by the following organizations

- **NVLAP – Lab Code: 200611-0**
SGS-CSTC Standards Technical Services Co., Ltd., Guangzhou EMC Laboratory is recognized under the National Voluntary Laboratory Accreditation Program (NVLAP/NIST) NVLAP Code 200611-0 Effective through December 31, 2006
- **ACA**
SGS-CSTC Standards Technical Services Co., Ltd., EMC Laboratory can also perform testing for the Australian C-Tick mark as a result of our NVLAP accreditation
- **VCCI**
The 3m Semi-anechoic chamber and Shielded Room (11.5m x 4m x 4m) of SGS-CSTC Standards Technical Services Co., Ltd. have been registered in accordance with the Regulations for Voluntary Control Measures with Registration No. R-1599 and C-1706 respectively
Date of Registration: June 01, 2005. Valid until February 22, 2008
- **SGS UK(Certificate No.: 32), SGS-TUV SAARLAND and SGS-FIMKO**
Have approved SGS-CSTC Standards Technical Services Co., Ltd., EMC Laboratory as a supplier of EMC TESTING SERVICES and SAFETY TESTING SERVICES
- **CNAL – LAB Code: L0141**
SGS-CSTC Standards Technical Services Co., Ltd., EMC Laboratory has been assessed and in compliance with CNAL/AC01 2002 accreditation criteria for testing laboratories (identical to ISO/IEC 17025 1999 General Requirements) for the Competence of Testing Laboratories
- **FCC – Registration No.: 282399**
SGS-CSTC Standards Technical Services Co., Ltd., EMC Laboratory has been registered and fully described in a report filed with the (FCC) Federal Communications Commission. The acceptance letter from the FCC is maintained in our files. Registration 282399, May 31, 2002. With the above and NVLAP's accreditation, SGS-CSTC is an authorised test laboratory for the DoC process
- **Industry Canada (IC)**
The 3m Semi-anechoic chamber of SGS-CSTC Standards Technical Services Co., Ltd. has been registered by Certification and Engineering Bureau of Industry Canada for radio equipment testing with Registration No. 5169

4.8 Deviation from Standards

None

4.9 Abnormalities from Standard Conditions

None

4.10 Monitoring of EUT for All Immunity Test

N/A

5 Emission Test Results

Test Requirement EN 61000-6-3
Test Method N/A See Remark Below

There is no need for emission tests to be performed on this product in accordance with standard EN 61000-6-3. Since the EUT does not contain emission source circuit or component inside

For further details, please refer to clause 8 of EN 61000-6-3 which states

" It may be determined from consideration of the electrical characteristics and usage of a particular apparatus that some of the measurements are inappropriate and therefore unnecessary. In such a case it is required that the decision not to measure be recorded in the test report "

6 Immunity Test Results

Test Requirement EN 61000-6-1
Test Method N/A See Remark Below

There is no need for immunity tests to be performed on this product in accordance with standard EN 61000-6-1. Since the EUT does not contain electromagnetic susceptible electronic circuit or component inside

For further details, please refer to clause 8 of EN61000-6-1 which states

" It was determined from consideration of the electrical characteristics and usage of a particular apparatus that some of the tests are inappropriate and therefore unnecessary "

7 Photographs – EUT Constructional Details

SPRO5001

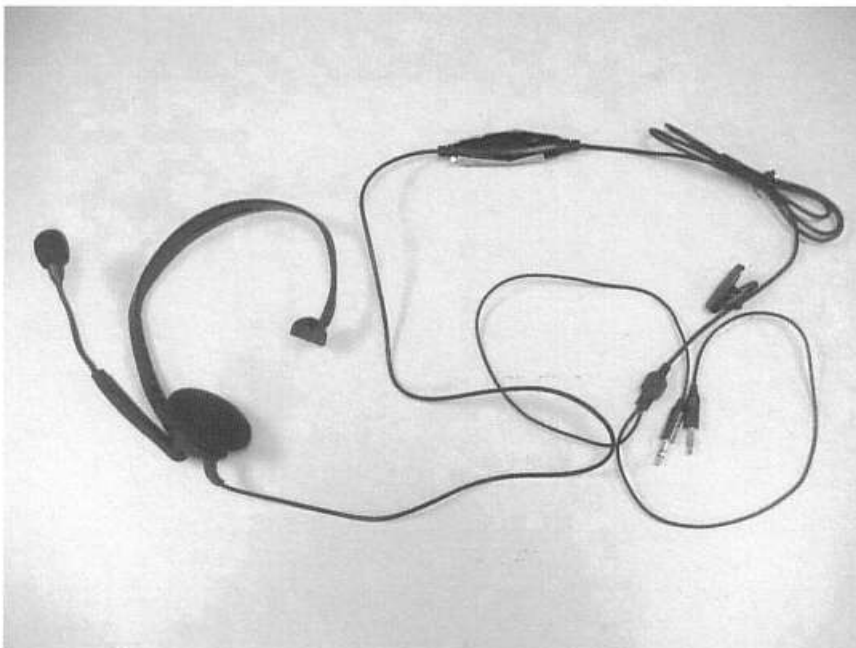
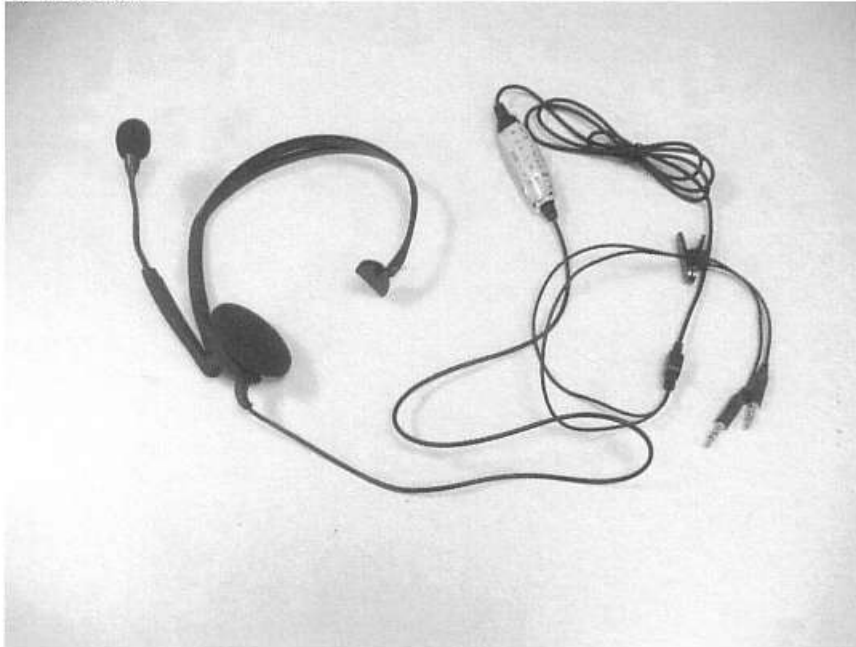

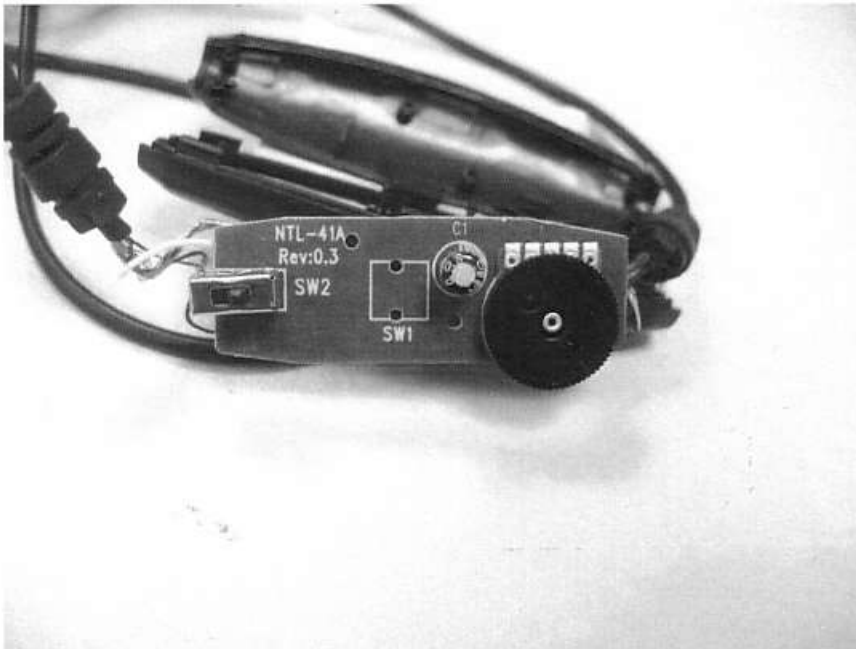

SPRO5002



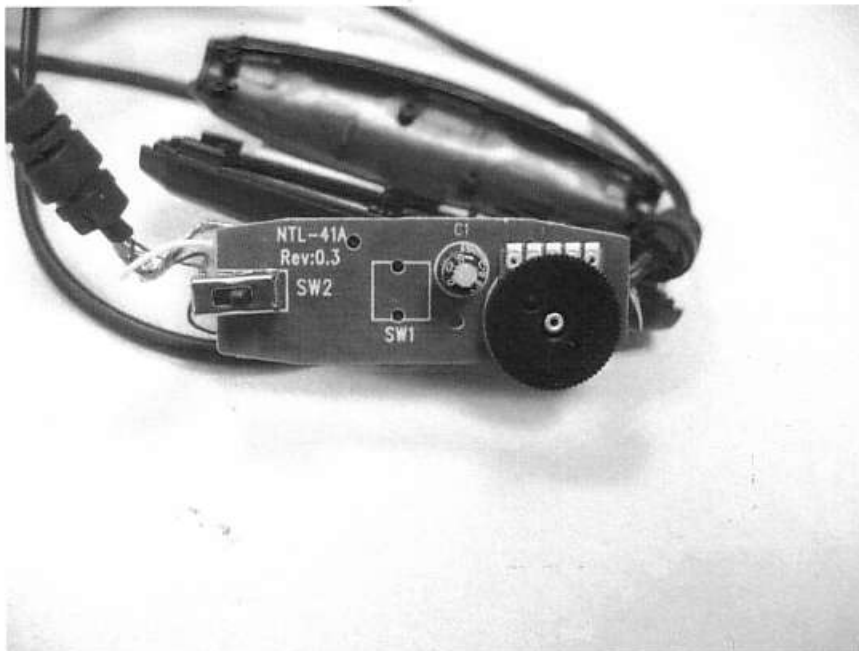

SPRO-5003

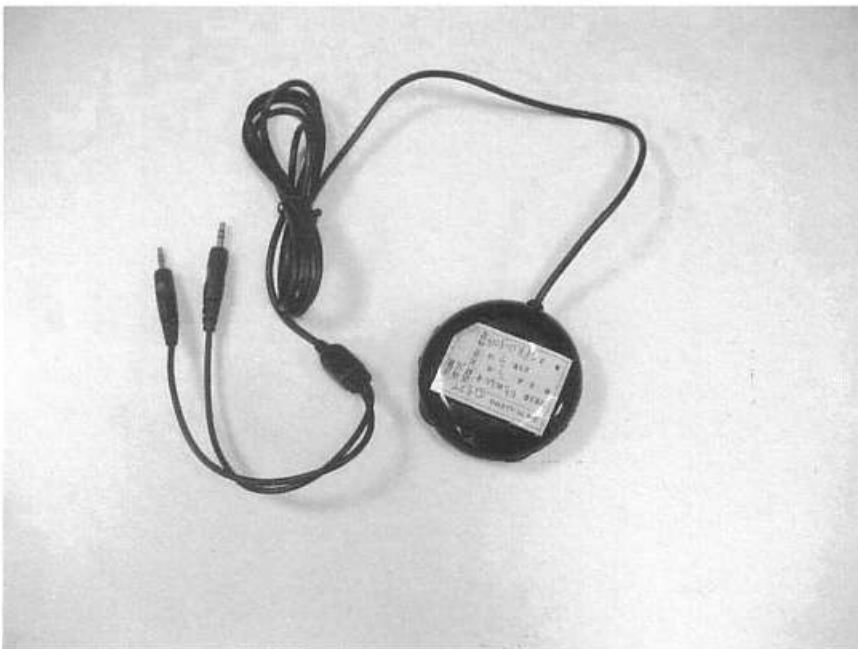
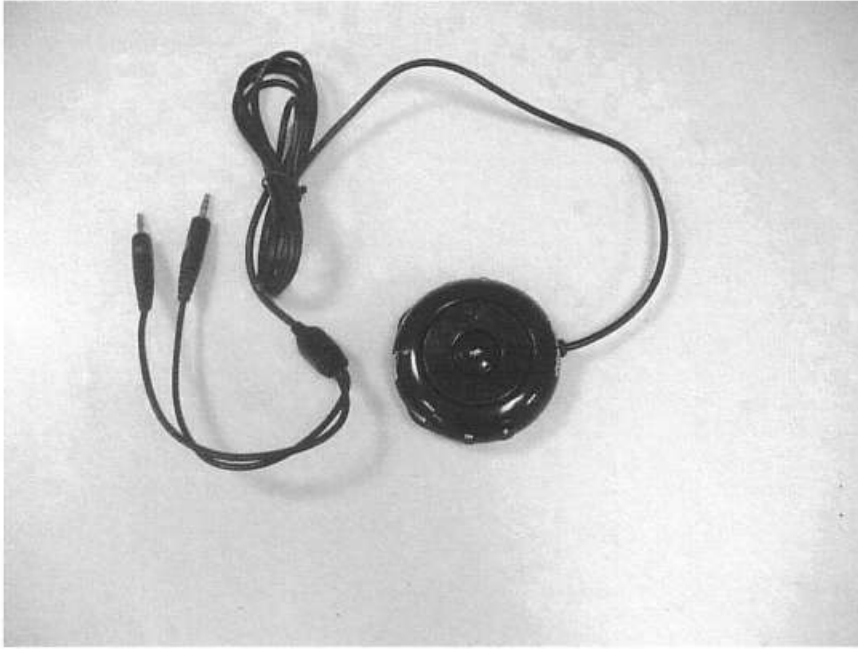

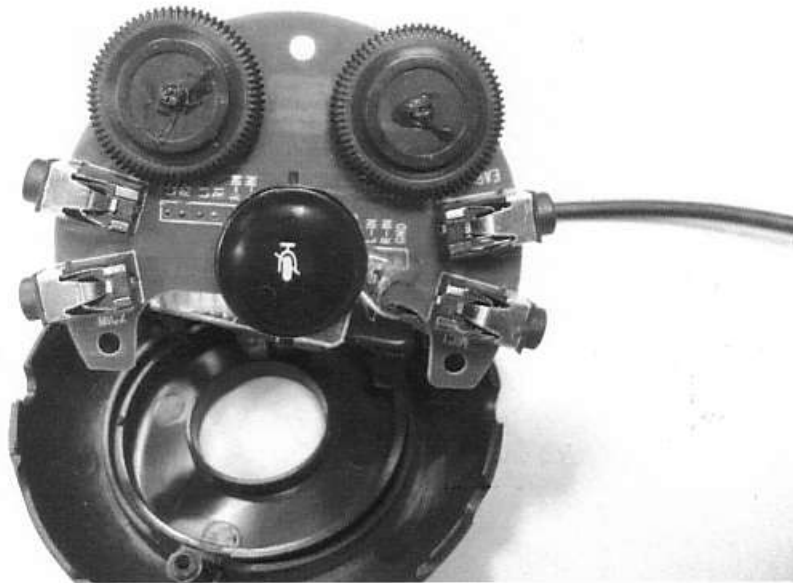
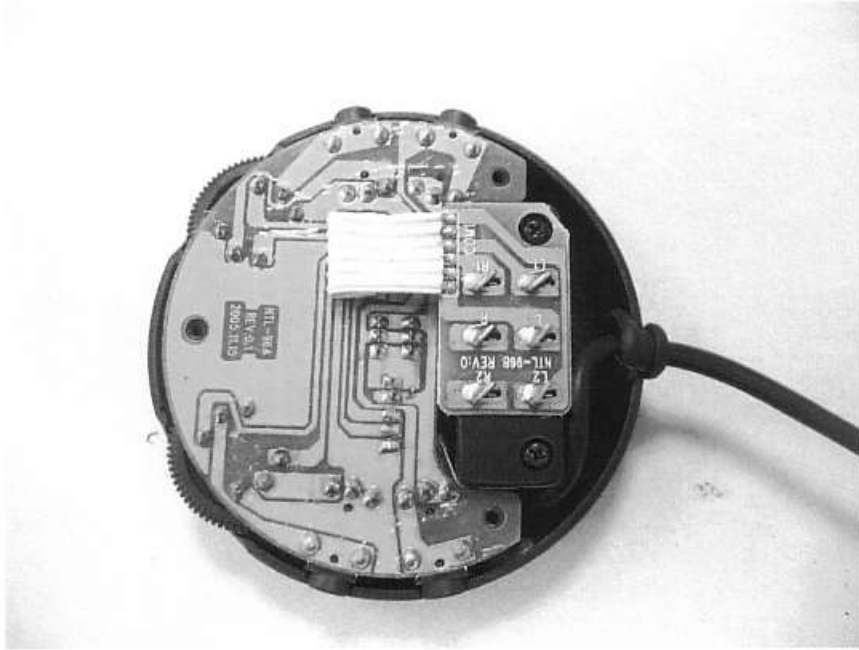

EC Declaration of Conformity

Council Directive 2004/108/EC on Electromagnetic Compatibility

We, ISS MANUFACTURING LTD.
UNIT 604-606, 6/F., PHASE II, CHAI WAN INDUSTRIAL CITY, 70
WING TAI ROAD, CHAI WAN, HONGKONG

Certify that the product described is in conformity with the
Directive 2004/108/EC as last amended by Directive 93/68/EEC

Product Name: HEADSET WITH MICROPHONE, AUDIO
SWITCH

Item No.: SPRO5001, SPRO5002, SPRO-5003

The product has been assessed by the application of the following standards:

EN 61000-6-3 : 2001+A11:2004 & EN 61000-6-1 : 2001

Issue date

Company stamp and Signature
of authorized personnel